

Article number: 03509200

Description: Fluro Rod end GE 200SX

Measures

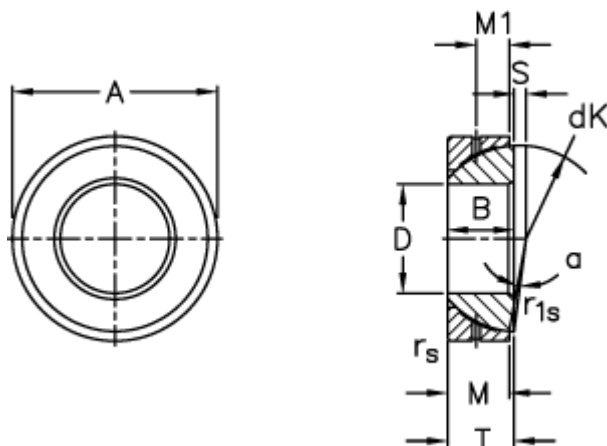

A	= 310 0 -0,035	S	= 26
B	= 70	Static load C0 (kN)	= 7800
D	= 200 0 -0,030	T	= 70 +0,35 -0,80
dK	= 290	Tilt angle	= 1.5
Dynamic load C (kN)	= 1560	Weight	= 22500
M	= 66		
M1	= 30		
rs, r1s min	= 3		